

CABINET UNIT HEATER SUBMITTAL DATA

CBS-A-15

Accessories

DUCT COLLAR
INLET AND DISCHARGE

SIZE	DIM "W"
02	18 1/8"
03	26 1/8"
04	30 1/8"
06	42 1/8"
08	44 1/8"
10	49 1/8"
12	56 1/8"
14	68 1/8"

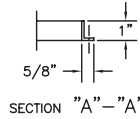
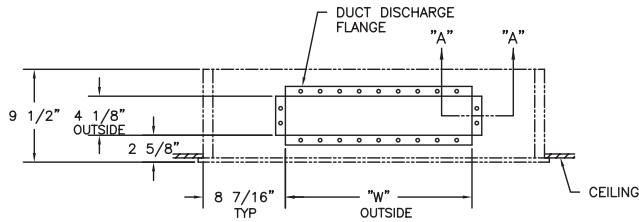

Option 114

WALL SEAL

SIZE	DIM "L"
02	35"
03	43"
04	47"
06	59"
08	61"
10	66"
12	73"
14	85"

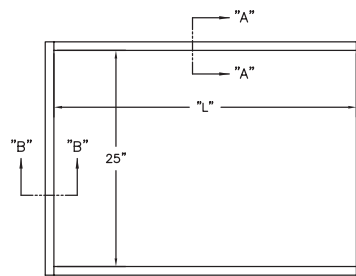
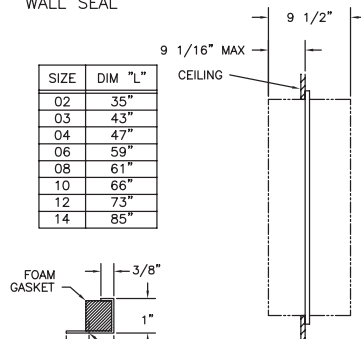

Option 126B

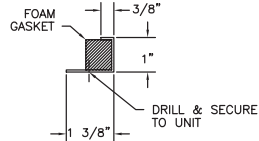

SECTION "A" - "A"

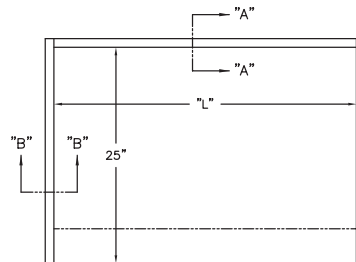
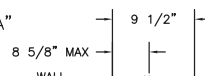

Option 126A

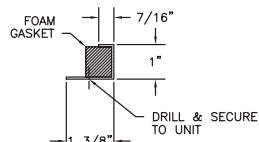

SECTION "B" - "B"

WALL SEAL 3/4"
(FOR F AND FI MODELS) IS OPTIONAL

WALL SEAL PIECES ARE ATTACHED TO UNIT
AFTER UNIT RECESS DEPTH IS DETERMINED.

CAT00206A

PROJECT: _____
 LOCATION: _____
 ARCHITECT: _____
 ENGINEER: _____
 CONTRACTOR: _____
 PO NUMBER: _____
 DATE: _____



260 NORTH ELM STREET, WESTFIELD, MA 01085
 TEL: (413) 568-9571 FAX: (413) 562-8437
 www.airthermhvac.com



CABINET UNIT HEATER SUBMITTAL DATA

CBS-A-15

Accessories

SIZE	DIM "A"	DIM "L"
02	6 1/8"	35"
03	6 1/8"	43"
04	6 1/8"	47"
06	10 5/8"	59"
08	10 5/8"	61"
10	10 5/8"	66"
12	16 5/8"	73"
14	16 5/8"	85"

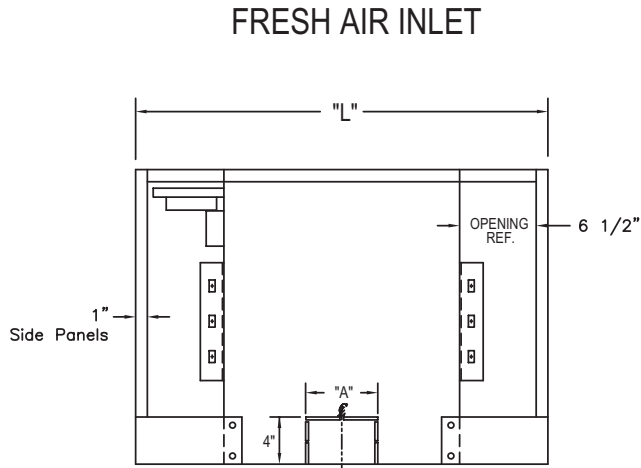

Option 118

Option 119

REAR VIEW
 FRESH AIR INLET
 OPENING IN INTERNAL CABINET
 KNOCKED OUT WHEN REQUIRED

Option 118 and 119

CAT00205B

